



FOOD EQUIPMENT

SERVING THE FOOD INDUSTRY SINCE 1951

Stagionello® & StagionelloEvo® Curing Cabinet

Model: STGPNTF60

Model: STAGIONELLO 150

Model: STG100TF0

Model: STG100300

Model: STGTWITF0

Model: STG200600

Model: STG200TF0



AGE MEAT ON AN AVERAGE OF ONLY

20 DAYS!



150kg Capacity
Model STAGIONELLO 150

100kg + 100kg Capacity
Model STGRWITFO

Stagionello^{evo} Stagionello[®]

Stagionello[®] contributes to environmental protection!

Only solar energy has been used for its construction
Saving 213.6 Kg of Co2 for every Stagionello[™]
produced equaling 74.760 Kg every year.

Every Stagionello[™] 
SAVES 213.6 Kg of CO₂ from our environment



WARRANTY
PARTS AND LABOR



PRODUCED USING
100%
Solar Energy



Authorized Dealer

FOOD EQUIPMENT

Stagionello® & StagionelloEvo® CURING CABINET



Stagionello®

Fumotic® ClimaTouch®

Produce salami on an average of only 20 days!

Stagionello® is the original and the first unit to create a series of microclimates ideal for traditional salami processing. On an average of only 20 days, Stagionello® can help you produce genuine meats without the need for chemical additives, such as colorants. The commercial grade system (non monoblock) allows for the optimal temperature in a short period time. Temperature is then maintained thanks to the unified structure of high-density, high compression, non-toxic polyurethane foam thermal insulation. Stagionello®, combined with Fumotic®, is able to produce and manage humidity, cold smoke and or flavor the product inside the chamber. Like the Stagionello®Evo, the control system automatically manages the temperature, humidity and air speed for the duration of the programmed phases: salting, stewing, smoking / aromatization, drying and seasoning. Stagionello® is made of stainless steel aisi 304 with a scotch-brite finish, both internally and externally where in contact with food. The stainless steel door (not aluminum) has a large glass panel with the key/lock system, so as to allow the use both in the kitchen/laboratory or in a retail area. In the laboratory, the large glass panel allows you to monitor the transformation process, in a retail area it can be used as a showcase to cure and display simultaneously. The four adjustable stainless steel legs allow for perfect stability. Optionally, the exterior can also be customized by choosing from a wide range of colors. These are just some of the features that gave our technology worldwide status, making us the most copied food transformation technology in recent history.



60kg Capacity
Model STGPNTF60



100kg Capacity
Model STG100TF0



200kg Capacity
Model STG200TF0



100kg + 100kg Capacity
Model STGTWTF0



100 + 300kg Capacity
Model STG100300



200 + 600kg Capacity
Model STG200600

Stagionello®Evo

Fumotic® ClimaTouch®

Produce salami on an average of only 20 days!

Stagionello®Evo, is the only curing cabinet guaranteed 100% made in Italy, patented with a rated load capacity of 150 kilograms. Our technologically advanced system is equipped with yet another patent, Fumotic®, this allows our unit to not only manage cooling, heating, air velocity, but also to produce and maintain the desired amount of humidity in a short period of time. The new control system used by Stagionello®Evo (Climatouch®) contains 30 classic Italian recipes preset into its memory, which can be modified by the user. To create your own product (eg salami milano) just scroll through the list and select the recipe name, Stagionello®Evo via the controller will automatically handle all production stages of that recipe. In the case of slow fermentation products (eg capicollo), even the delicate salting phase is automatically managed. Climatouch® allows you to create and save custom recipes, it could be an old family recipe, or create salami types from other countries as well. Stagionello®Evo comes standard with an evolved system of HACCP that meets all international standards.



150kg Capacity
Model STAGIONELLO 150

**ONLY MODEL
OF ITS KIND**

Special features:

- Equipped with dual internal fans
- Air exchange kit included

OMCAN INC.

Telephone: 1-800-465-0234

Fax: (905) 607-0234

Email: sales@omcan.com

Website: www.omcan.com



Follow us to keep up to date with the latest news and offers



FOOD EQUIPMENT

Stagionello® & StagionelloEvo® CURING CABINET

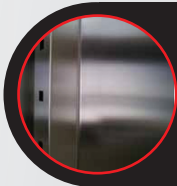

Made in Stainless Steel AISI 304

The most important advantage of using stainless steel AISI 304 is the fact that it is non-porous and easier to clean



Energy Efficient

The AISI 304 Stainless Steel body and doors are fully injected with CFC free polyurethane foam creating a unibody frame and higher R-value

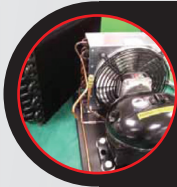

Professional grade Non Monoblock system

Our non monoblock system is comprised of various components specially designed with the capability to be used for seasoning and dry aging, and can function in an ambient temperature range for up to +32°C (89.6°F)



Alarms

There are a number of alarms built into the system to protect the Stagionello®

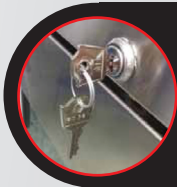

Lock and Key

Equipped with a lock and key system for additional safety



Probes

There are 4 standard probes included in all Stagionello® units

- Humidity probe which monitors the ambient humidity inside the entire chamber
- Ambient probe to monitor the temperature inside the entire chamber
- Evaporator/defrost probe to visualize the temperature of evaporation and controls the temperature of defrosting in order to conserve energy
- Condenser probe to visualize the temperature of the condenser

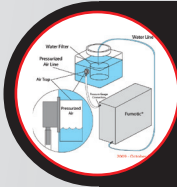

Tank

The tank system is designed to work with the Fumotic® to provide humidity when needed and aroma flavor as desired by the user.



Doors

The doors are designed and built in AISI 304 stainless steel, dual insulated glass panels with UV protection of 59%, pressure valve for high altitudes, resistance lines to minimize condensation and soften door seals at lower temperatures.

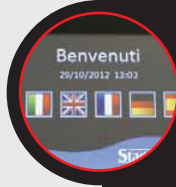

Climatouch®

A revolutionary automatic control system with a 6-inch touch screen display that automatically manages all sequential processing stages, calculating pH levels during the fermentation process guaranteeing a quality product. It includes preset recipes and allows the user to have access to the system which controls the functionality of the unit.

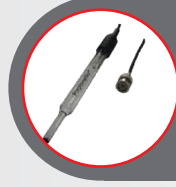

Pre-Calibrated pH Probe

Our pH probe is designed to connect to a PLC and communicate data from the product to the Display, record and store it for later use.



Fumotic®

This is a dual purpose system for regulating humidity and flavoring

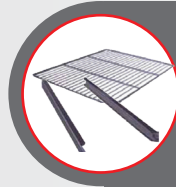

Guide Sets, Hanging Rods, Grills/Racks

(Only apply to STGPNTF60, STG100TF0 & STGTWTF0)

Standard guide sets and rods are made from AISI 304 and are suited to distribute the weight of the maximum amount of product designed for that unit.



Adjustable Legs

All units are equipped with AISI 304 stainless steel adjustable legs for uneven floors. There is an optional 13cm (5.2") wheel kit available for those who need increased mobility.

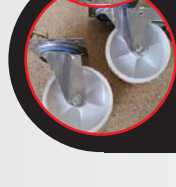

Produce your Salami traditionally all year round

OMCAN INC.

Telephone: 1-800-465-0234

Fax: (905) 607-0234

Email: sales@omcan.com

Website: www.omcan.com



Follow us to keep up to date with the latest news and offers



2023 E&OE

FOOD EQUIPMENT

Stagionello® & StagionelloEvo® CURING CABINET



100kg Capacity

Model STG100TF0
Item 41474

TECHNICAL DRAWING AND DIMENSIONS

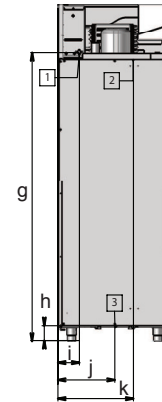
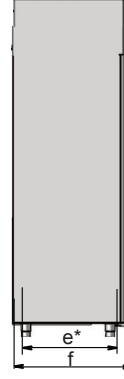
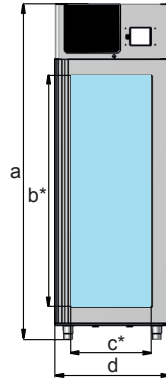

Dimensions:

- a. 2110 mm
- b. 1360 mm*
- c. 530 mm*
- d. 730 mm
- e. 650 mm*
- f. 780 mm
- g. 1790 mm
- h. 140 mm
- i. 135 mm
- j. 420 mm
- k. 600 mm



150kg Capacity

Model STAGIONELLO 150
Item 40298

TECHNICAL DRAWING AND DIMENSIONS

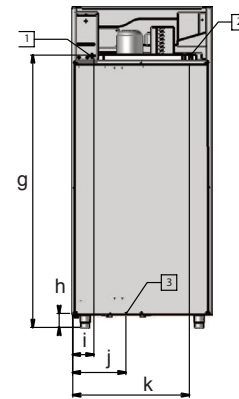
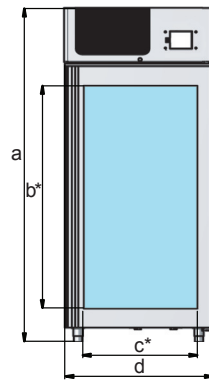

Dimensions:

- a. 2110 mm
- b. 1360 mm*
- c. 710 mm*
- d. 905 mm
- e. 650 mm*
- f. 780 mm
- g. 1790 mm
- h. 140 mm
- i. 135 mm
- j. 310 mm
- k. 780 mm

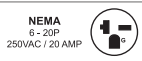

1. Water inlet 3/4" Dia. 2. Electrical connection 220v 3. Water outlet 1/2" Dia. *Internal dimensions

TECHNICAL SPECIFICATIONS

ITEM NUMBER	41474	40298
MODEL	STG100TF0	STAGIONELLO 150
DESCRIPTION	Stagionello® 100kg cabinet with ClimaTouch® and Fumotic®	StagionelloEvo® 150kg cabinet with ClimaTouch® and Fumotic® - Silver
INTERIOR	4 Guide sets/ 20 stainless steel hanging rods	4 Guide sets/ 20 stainless steel hanging rods
WORKING TEMPERATURE	-5 - 50 °C/ 23 - 122°F	-5 - 50 °C/ 23 - 122°F
STORAGE TEMPERATURE	-10 - 70 °C/ 14 - 158°F	-10 - 70 °C/ 14 - 158°F
AMBIENT RELATIVE HUMIDITY	Less than 90% RH	Less than 90% RH
ELECTRICAL	220V/2.6kW/11A	220V/3.42kW/14A
INTERNAL MEMORY	352 Kb Ram (approx.100 recipes)	352 Kb Ram (approx.100 recipes)
NET WEIGHT	140 kg (308lbs)	200 kg (440lbs)
GROSS WEIGHT	212 kg (466.4 lbs)	296 kg (651.2 lbs)
DIMENSIONS (WDH)	28.74" x 30.7" x 83"/ 730 x 780 x 2110 mm	35.6" x 30.7" x 83"/ 905 x 780 x 2110 mm

OMCAN INC.

Telephone: 1-800-465-0234
 Fax: (905) 607-0234
 Email: sales@omcan.com
 Website: www.omcan.com



Follow us to keep up to date with the latest news and offers



FOOD EQUIPMENT

Stagionello® & StagionelloEvo® CURING CABINET



60kg Capacity
Model STGPNTF60
Item 44954

TECHNICAL DRAWING AND DIMENSIONS

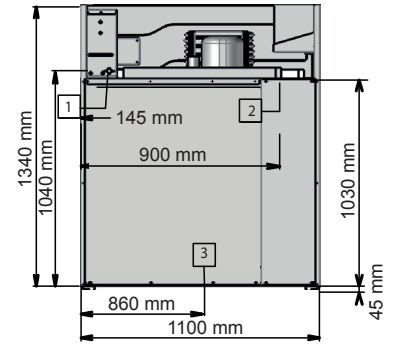
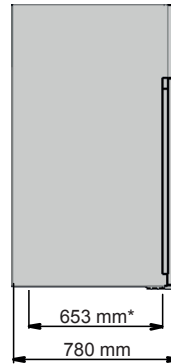
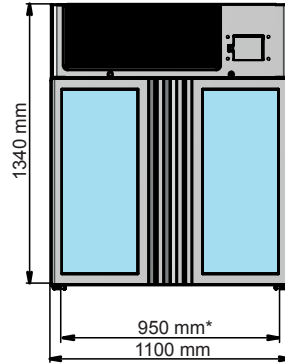

**100kg +
100kg Capacity**
Model STGTWTF0
Item 41262



200kg Capacity
Model STG200TF0
Item 45232

TECHNICAL DRAWING AND DIMENSIONS

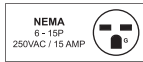
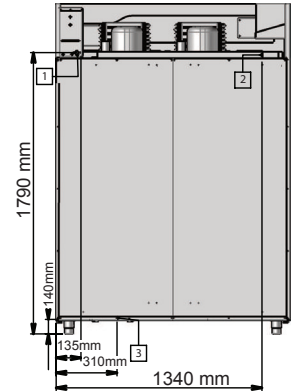
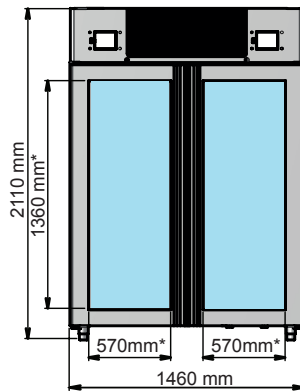

1. Water inlet 3/4" Dia. 2. Electrical connection 220v 3. Water outlet 1/2" Dia. *Internal dimensions

TECHNICAL SPECIFICATIONS

ITEM NUMBER	44954	41262	45232
MODEL	STGPNTF60	STGTWTF0	STG200TF0
DESCRIPTION	Stagionello® 60kg wall cabinet with ClimaTouch® and Fumotic®	Stagionello® 100kg + 100kg cabinet with ClimaTouch® and Fumotic®	Stagionello® 200kg cabinet with ClimaTouch® and Fumotic®
INTERIOR	2+2 Guide sets/ 10+10 stainless steel hanging rods	4+4 Guide sets/ 20+20 stainless steel hanging rods	
WORKING TEMPERATURE	-5 - 50 °C/ 23 - 122°F	-5 - 50 °C/ 23 - 122°F	
STORAGE TEMPERATURE	-10 - 70 °C/ 14 - 158°F	-10 - 70 °C/ 14 - 158°F	
AMBIENT RELATIVE HUMIDITY	Less than 90% RH		
ELECTRICAL	220V/2.6kW/11A	220V/3.21kW/14.6A	220V/4.19kW/18.2A
INTERNAL MEMORY	352 Kb Ram (approx. 100 recipes)		
NET WEIGHT	150 kg (330 lbs)	250 kg (550 lbs)	
GROSS WEIGHT	226 kg (497.2 lbs)	362 kg (798 lbs)	
DIMENSIONS (WDH)	43.3" x 30.7" x 52.75"/ 1100 x 780 x 1340 mm	57.48" x 30.7" x 83"/ 1460 x 780 x 2110 mm	

OMCAN INC.

Telephone: 1-800-465-0234
Fax: (905) 607-0234
Email: sales@omcan.com
Website: www.omcan.com



Follow us to keep up to date with the latest news and offers



FOOD EQUIPMENT

Stagionello® & StagionelloEvo® CURING CABINET



100 + 300kg Capacity
Model STG100300

TECHNICAL DRAWING AND DIMENSIONS

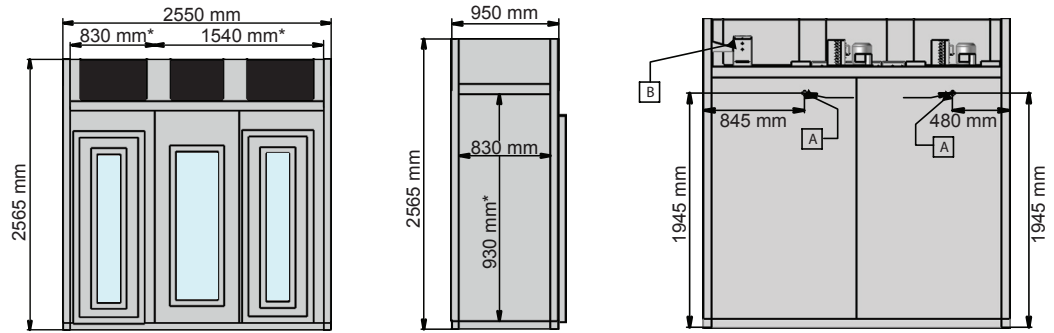

200kg + 600kg Capacity
Model STG200600

TECHNICAL DRAWING AND DIMENSIONS

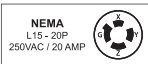
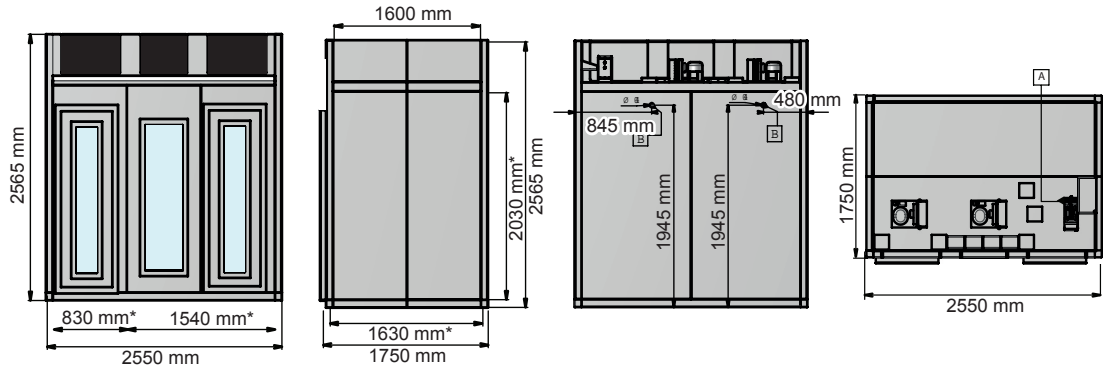

A: Drain 20 mm

B: Fumotic

*Internal dimensions

TECHNICAL SPECIFICATIONS

ITEM NUMBER	45485	45487
MODEL	STG100300	STG200600
DESCRIPTION	Stagionello® 100 + 300kg cabinet with ClimaTouch® and Fumotic®	Stagionello® 200kg + 600kg cabinet with ClimaTouch® and Fumotic®
INTERIOR	Automatic internal lighting, dehumidifier, air exchange, heated frame, hot gas defrost, and industrial refrigeration unit.	Automatic internal lighting, dehumidifier, air exchange, heated frame, hot gas defrost, and industrial refrigeration unit.
WORKING TEMPERATURE	-5 - 50 °C/ 23 - 122°F	-5 - 50 °C/ 23 - 122°F
STORAGE TEMPERATURE	-10 - 70 °C/ 14 - 158°F	-10 - 70 °C/ 14 - 158°F
AMBIENT RELATIVE HUMIDITY	Less than 90% RH	Less than 90% RH
ELECTRICAL	380V/7.12kW/10.32A	380V/8.6kW/12.5A
INTERNAL MEMORY	352 Kb Ram (approx.100 recipes)	352 Kb Ram (approx.100 recipes)
DIMENSIONS (WDH)	100" x 37.4" x 101" / 2550 x 950 x 2565 mm	100" x 69" x 101" / 2550 x 1750 x 2565 mm

OMCAN INC.

Telephone: 1-800-465-0234

Fax: (905) 607-0234

Email: sales@omcan.com

Website: www.omcan.com



Follow us to keep up to date with the latest news and offers



2023 E&OE